

# Up/Down Counter/Timer

## DIN W72 × H36mm of Counter/Timer with indication only

### ■ Features

- Upgraded counting speed : 1cps/30cps/2kcps/5kcps
- Application of Up/Down input mode
- Selectable Up/Down indication of display value
- Wide range of input power supply :  
100–240VAC 50/60Hz, 12–24VAC/DC
- Selectable Counter or Timer function by internal DIP switch
- Selectable time ranges
- Built-in Microprocessor



**⚠ Please read "Caution for your safety" in operation manual before using.**



### ■ Ordering information

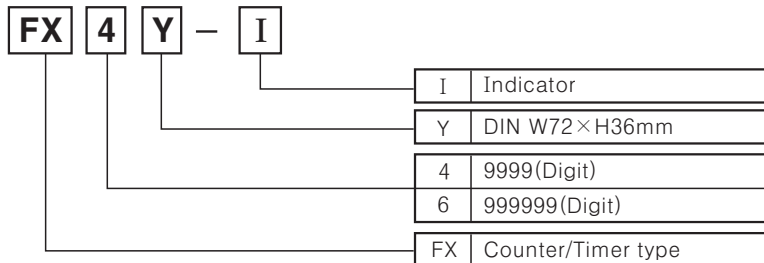

### ■ Specifications

Model	FX4Y-I	FX6Y-I
Digit	4	6
Digit size	W8 × H14mm	W4 × H8mm
Power supply	100–240VAC 50/60Hz, 12–24VAC/DC	
Allowable voltage range	90 ~ 110% of rated voltage	
Power consumption	Approx. 4.5VA (240VAC 60Hz), Approx. 4.5VA (24VAC 60Hz), Approx. 2.5W (24VDC)	
Max. counting speed	Selectable 1cps/30cps/2kcps/5kcps by internal DIP switch	
Min. input signal width	INHIBIT input	Min. 20ms
	RESET input	
Input	CP1, CP2 input	No voltage input ⇒ Impedance at short-circuit : Max. 470Ω, Residual voltage at short-circuit : Max. 1VDC, Impedance at open-circuit : Min. 100kΩ
	RESET input	
Memory protection	10 years (When using non-volatile semiconductor memory)	
External power	12VDC ± 10% 50mA Max.	
Insulation resistance	Min. 100MΩ (at 500VDC mega)	
Dielectric strength	2000VAC 50/60Hz for 1 minute	
Noise strength	AC Type	± 2kV the square wave noise (pulse width: 1μs) by the noise simulator
	DC Type	± 500V the square wave noise (pulse width: 1μs) by the noise simulator
Vibration	Mechanical	0.75mm amplitude at frequency of 10 ~ 55Hz in each of X, Y, Z directions for 1 hour
	Malfunction	0.5mm amplitude at frequency of 10 ~ 55Hz in each of X, Y, Z directions for 10 minutes
Shock	Mechanical	300m/s <sup>2</sup> (Approx. 30G) in X, Y, Z directions for 3 times
	Malfunction	100m/s <sup>2</sup> (Approx. 10G) in X, Y, Z directions for 3 times
Ambient temperature	-10 ~ +55°C (at non-freezing status)	
Storage temperature	-25 ~ +65°C (at non-freezing status)	
Ambient humidity	35 ~ 85%RH	
Life cycle	Semi-permanent	
Unit weight	AC type: Approx. 126g, DC type: Approx. 130g	AC type: Approx. 128g, DC type: Approx. 132g
Approval		

(A) Counter

(B) Timer

(C) Temp. controller

(D) Power controller

(E) Panel meter

(F) Tacho/Speed/Pulse meter

(G) Display unit

(H) Sensor controller

(I) Switching power supply

(J) Proximity sensor

(K) Photo electric sensor

(L) Pressure sensor

(M) Rotary encoder

(N) Stepping motor & Driver & Controller

(O) Graphic panel

(P) Production stoppage models & replacement

# FXY Series

## Connections

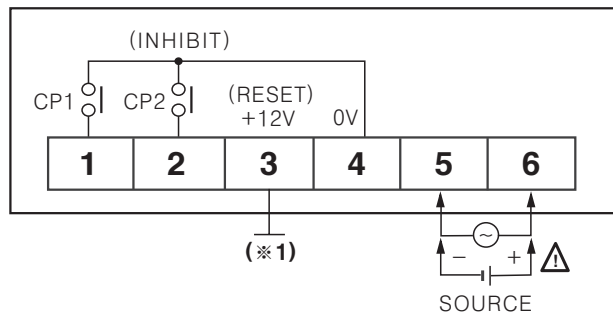

- (※1) It can be selected RESET or sensor power (+12V 50mA) by internal PIN operation. (Refer to A-35)
- (※2) CP1, CP2 : Input signal terminals when using as Counter.
- (※3) INHIBIT(CP2) : Time Hold terminal when using for timer (Connect switch to ②+④ from the external.)
- (※4) Operated by a Power ON Start method when it is used as a timer.

## Input connections

◎Using for no-voltage input(NPN)

●Solid-state input(Standard sensor : NPN output type sensor)

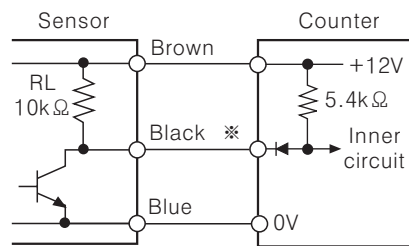

※CP1, CP2(INHIBIT), RESET input

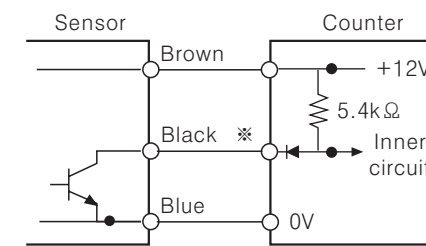

(NPN open collector output)

●Contact input

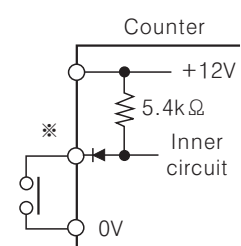

※Please select the counting speed as 30cps when using for counter.

◎Using for voltage input(PNP)

FXY series is for no-voltage input type, it is not available to count applying DC voltage from the external. For using PNP type sensor, please use as the following to count.

●PNP output type sensor

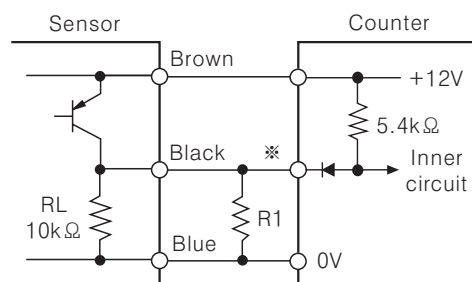

(PNP output)

●Please set R1 value to make the composed resistance of  $RL + R1$  as Max. 470kΩ is an impedance for short-circuit.

※CP1, CP2(INHIBIT), RESET input

●PNP open collector output type sensor

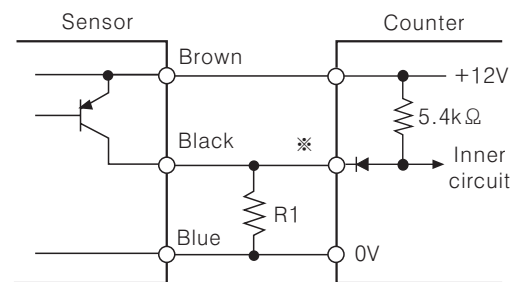

(PNP open collector output)

※In case of PNP open collector output type sensor, please connect lower than 470Ω of R1 to input terminal before using.

# Up/Down Counter/Timer

## Counting method

Be careful to select sensor because the counting method of NPN output type sensor is different from PNP output type sensor.

### ●NPN output type sensor

When the sensor is changed from OFF to ON, it counts.

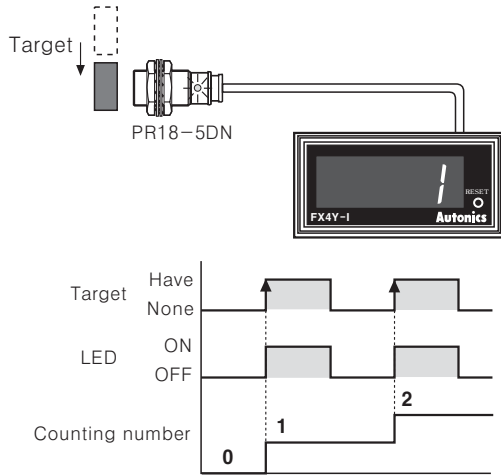

### ●PNP output type sensor

When the sensor is changed from ON to OFF, it counts.

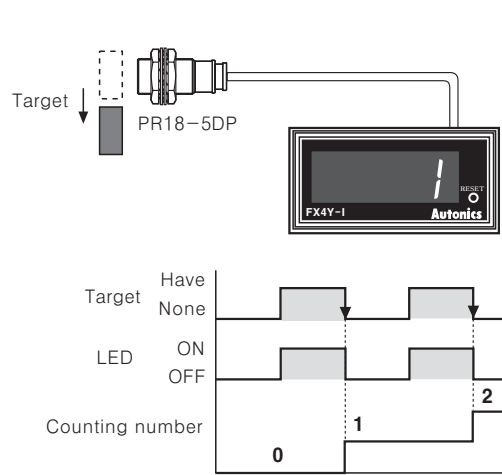

## Dimensions

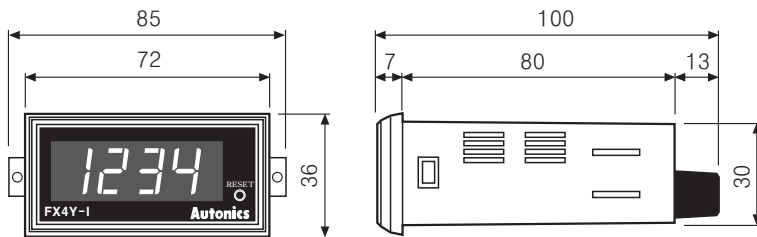

### ●Panel cut-out

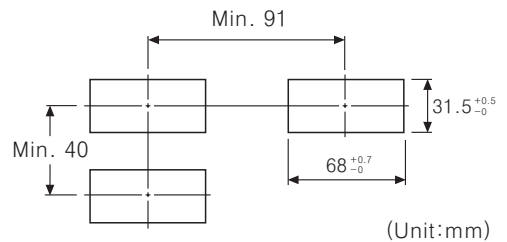

## Counting function of indication type(Counter)

### ●Up mode

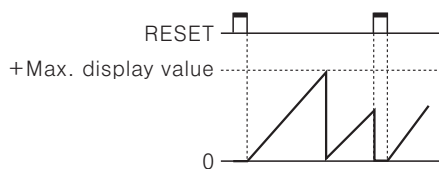

### ●Down mode

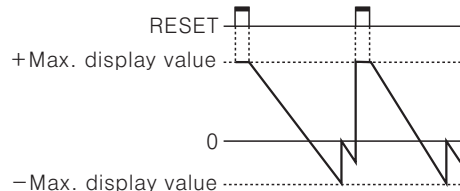

### ●Up/Down-A, B, C Mode

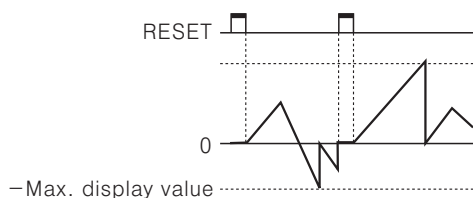

### ●Up/Down-D, E, F Mode

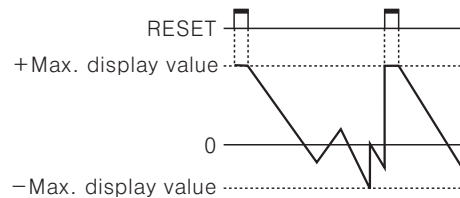

## Counting function of indication type(Timer)

### ●Up mode

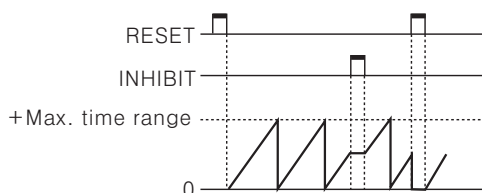

### ●Down mode

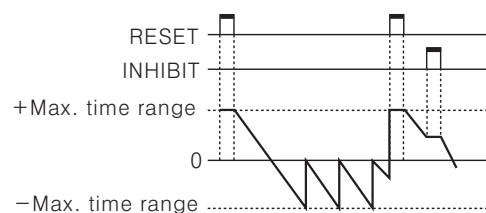

(A)  
Counter

(B)  
Timer

(C)  
Temp.  
controller

(D)  
Power  
controller

(E)  
Panel  
meter

(F)  
Tacho/  
Speed/  
Pulse  
meter

(G)  
Display  
unit

(H)  
Sensor  
controller

(I)  
Switching  
power  
supply

(J)  
Proximity  
sensor

(K)  
Photo  
electric  
sensor

(L)  
Pressure  
sensor

(M)  
Rotary  
encoder

(N)  
Stepping  
motor &  
Driver &  
Controller

(O)  
Graphic  
panel

(P)  
Production  
stoppage  
models &  
replacement

# FXY Series

## ■ Description of inner DIP switches

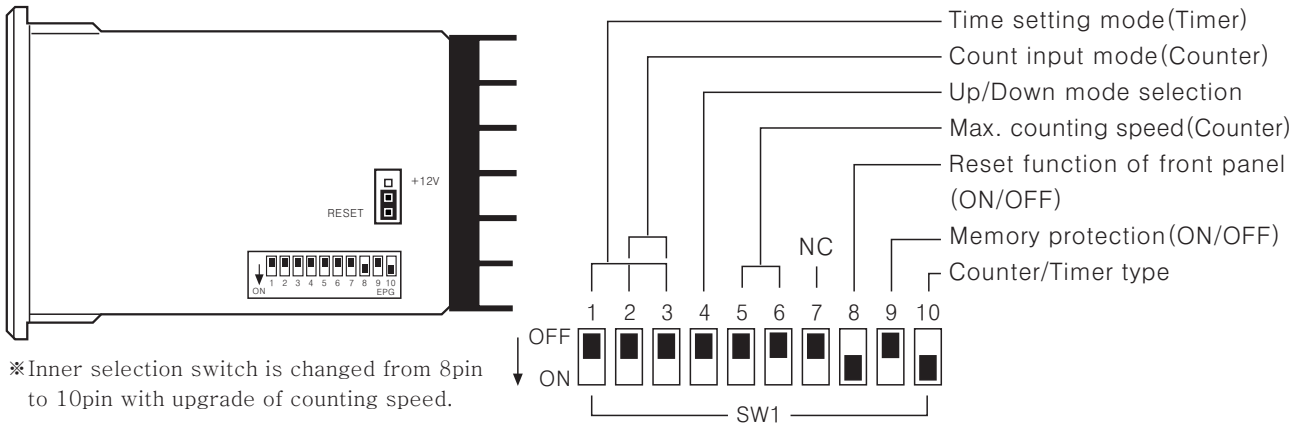

### ●Up/Down mode

SW1	Function
4 OFF <input type="checkbox"/> ON <input type="checkbox"/>	Up mode
4 OFF <input type="checkbox"/> ON <input type="checkbox"/>	Down mode

### ●Counter/Timer selection

SW1	Function
10 OFF <input type="checkbox"/> ON <input type="checkbox"/>	Timer
10 OFF <input type="checkbox"/> ON <input type="checkbox"/>	Counter

### ●Reset function of front panel(ON/OFF)

SW1	Function
8 OFF <input type="checkbox"/> ON <input type="checkbox"/>	Disable the front panel reset function
8 OFF <input type="checkbox"/> ON <input type="checkbox"/>	Enable the front panel reset function

### ●Max. counting speed

SW1	CP1, CP2
5 6 OFF <input type="checkbox"/> ON <input type="checkbox"/>	1cps
5 6 OFF <input type="checkbox"/> ON <input type="checkbox"/>	30cps
5 6 OFF <input type="checkbox"/> ON <input type="checkbox"/>	2kcps
5 6 OFF <input type="checkbox"/> ON <input type="checkbox"/>	5kcps

### ●Memory protection(ON/OFF)

SW1	Function
9 OFF <input type="checkbox"/> ON <input type="checkbox"/>	Enable the memory protection
9 OFF <input type="checkbox"/> ON <input type="checkbox"/>	Disable the memory protection

## ■ Time setting mode(Timer)

SW1	4Digit	6Digit	SW1	4Digit	6Digit
<b>A</b> OFF <input type="checkbox"/> ON <input type="checkbox"/>	<b>99.99sec</b>	<b>99999.9sec</b>	<b>E</b> OFF <input type="checkbox"/> ON <input type="checkbox"/>	<b>999.9min</b>	<b>99999.9min</b>
<b>B</b> OFF <input type="checkbox"/> ON <input type="checkbox"/>	<b>999.9sec</b>	<b>999999sec</b>	<b>F</b> OFF <input type="checkbox"/> ON <input type="checkbox"/>	<b>99hour 59min</b>	<b>99hour 59min 59sec</b>
<b>C</b> OFF <input type="checkbox"/> ON <input type="checkbox"/>	<b>9999sec</b>	<b>99min 59.99sec</b>	<b>G</b> OFF <input type="checkbox"/> ON <input type="checkbox"/>	<b>999.9hour</b>	<b>9999hour 59min</b>
<b>D</b> OFF <input type="checkbox"/> ON <input type="checkbox"/>	<b>99min 59sec</b>	<b>999min 59.9sec</b>	<b>H</b> OFF <input type="checkbox"/> ON <input type="checkbox"/>	<b>9999hour</b>	<b>99999.9hour</b>

# Up/Down Counter/Timer

## Input mode(Counter)

Input mode	SW1	4 OFF ON <b>Up mode</b>	Input mode	SW1	4 OFF ON <b>Down mode</b>
Up/Down-A (Command input)	OFF 2 3 ON		Up/Down-D (Command input)	OFF 2 3 ON	
Up/Down-B (Individual input)	OFF 2 3 ON		Up/Down-E (Individual input)	OFF 2 3 ON	
Up/Down-C (Phase difference input)	OFF 2 3 ON		Up/Down-F (Phase difference input)	OFF 2 3 ON	
UP (Count up input)	OFF 2 3 ON		Down (Count down input)	OFF 2 3 ON	

※(A) : Over Min. signal width, (B) : Over 1/2 of Min. signal width.

If the signal width of (A) or (B) is less than min. signal width,  $\pm 1$  of count error is occurred.

※n : + Max.display value (FX4Y-I : 9999, FX6Y-I : 999999)

(A)  
Counter

(B)  
Timer

(C)  
Temp.  
controller

(D)  
Power  
controller

(E)  
Panel  
meter

(F)  
Tacho/  
Speed/  
Pulse  
meter

(G)  
Display  
unit

(H)  
Sensor  
controller

(I)  
Switching  
power  
supply

(J)  
Proximity  
sensor

(K)  
Photo  
electric  
sensor

(L)  
Pressure  
sensor

(M)  
Rotary  
encoder

(N)  
Stepping  
motor &  
Driver &  
Controller

(O)  
Graphic  
panel

(P)  
Production  
stoppage  
models &  
replacement

# FXY Series

## ■ Proper usage

### ◎ Reset

#### ● Reset

When selecting a reset input/output mode, please apply the external reset or manual reset signal.

**If it is not reset, it is operated as the prior mode.**

#### ● Reset signal width

It is reset perfectly when the reset signal is applied for **max. 20ms** regardless of the contact input & solid-state input.

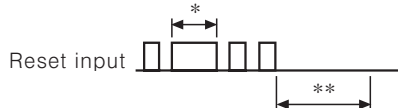

\*In case of a contact reset, it is reset perfectly if the ON time of reset signal is applied for max. 20ms even though a chattering is occurred.

\*\*Signal input (CP1, CP2) is possible if there is no reset input for min. 50ms after reset input.

### ◎ Min. signal width

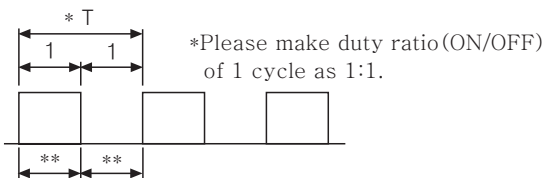

\*\* Min. signal width [ 30cps : Over 16.7ms  
2kcps : Over 0.25ms

### ◎ Maximum counting speed

This is a response speed per 1 sec. when the duty ratio (ON:OFF) of input signal is 1:1.

If the duty ratio is not 1:1, the width between ON and OFF should be over min. signal width and the response speed will getting slower against input signal. And one of ON width and OFF width is under min. signal width, this product may not response.

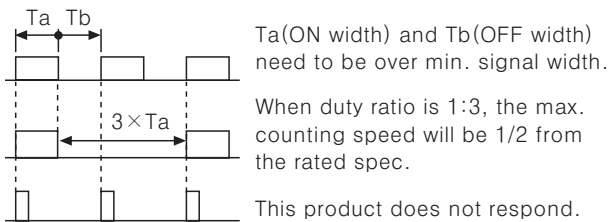

### ◎ Detach the case from body

While pushing the Lock part with with driver to the front, push the terminal block.

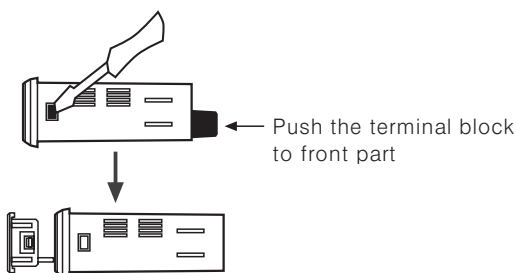

### ◎ Using switching pin of Reset / +12V

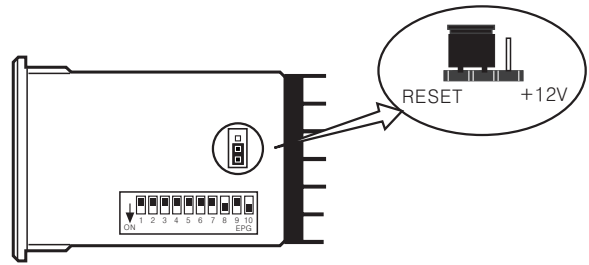

#### ● When using terminal 3 for external reset terminal

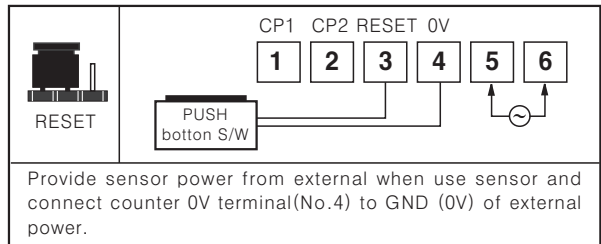

#### ● When using terminal 3 for sensor power terminal

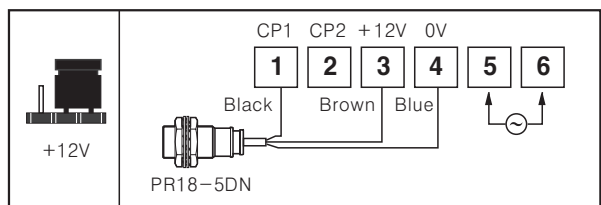

### ◎ INHIBIT [For Timer]

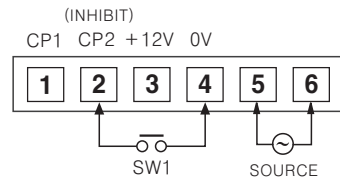

- It becomes the INHIBIT mode when SW1 turns on. (Time Hold)
- When power is applied, it starts to progress and INHIBIT mode is used to stop the time is under the progress at the moment.
- When SW1 is OFF, timer starts to progress again.

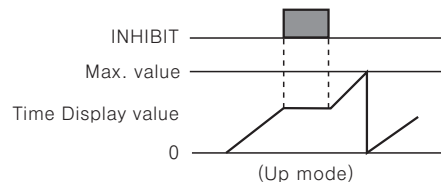

### ◎ Power

The inner circuit voltage starts to rise up for the first 100ms after power on, the input may not work at this time. And also the inner circuit voltage drops down for the last 500ms after power off, the input may not work at this time.

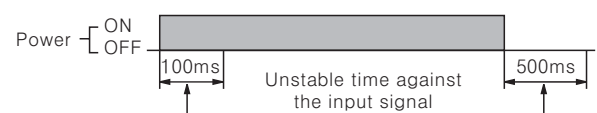

# Up/Down Counter/Timer

## DIN W48 × H48mm, Preset Counter/Timer

### ■ Features

- Upgraded counting speed : 1cps/30cps/2kcps/5kcps
- Selectable voltage input (PNP) or No-voltage input (NPN)
- Addition of Up/Down input mode
- Available to set a decimal point (Fixed decimal point of display)
- Wide range of input power supply :  
100–240VAC 50/60Hz, 12–24VAC/DC (Option)
- Selectable Counter/Timer by internal DIP switch
- Various time range
- Built-in Microprocessor



**⚠ Please read "Caution for your safety" in operation manual before using.**



### ■ Specifications

Model	Single preset		FX4S		FX5S-I	
	Dual preset					
Digit			4		5	
Digit size			W4×H8mm			
Power supply			100–240VAC 50/60Hz, 12–24VAC/DC (Option)			
Allowable voltage range			90 ~ 110% of rated voltage			
Power consumption			<ul style="list-style-type: none"> <li>• Indication type : Approx. 4.7VA (240VAC 60Hz), Approx. 5.6VA (24VAC 60Hz), Approx. 2.8W (24VDC)</li> <li>• Single preset : Approx. 5.7VA (240VAC 60Hz), Approx. 4.5VA (24VAC 60Hz), Approx. 3W (24VDC)</li> </ul>			
Max. counting speed for CP1, CP2			Selectable 1cps/30cps/2kcps/5kcps by internal DIP switch			
Min. input signal width	INHIBIT input		Approx. 20ms			
	RESET input					
Input	CP1, CP2 input (INHIBIT)		Input logic is selectable [Voltage input] Input impedance : 5.4kΩ "H" level : 5–30VDC, "L" level : 0–2VDC [No-voltage input] Impedance at short-circuit : Max. 1kΩ, Residual voltage at short-circuit : Max. 2VDC, Impedance at open-circuit : Max. 100kΩ			
	RESET input					
One-shot output time			0.05 ~ 5sec			
Control output	Contact	Type	SPDT (1c)			
		Capacity	250VAC 3A at resistive load			
	Solid-state	Type	NPN open collector			
		Capacity	30VDC Max. 100mA Max.			
Memory protection			10 years (When using non-volatile semiconductor memory)			
External power			12VDC ±10% 50mA Max.			
Dielectric strength			Min. 100MΩ (at 500VDC mega)			
Insulation resistance			2000VAC 50/60Hz for 1 minute			
Noise strength	AC power		±2kV the square wave noise (pulse width:1μs) by the noise simulator			
	DC power		±500V the square wave noise (pulse width:1μs) by the noise simulator			
Vibration	Mechanical		0.75mm amplitude at frequency of 10 ~ 55Hz in each of X, Y, Z directions for 1 hour			
	Malfunction		0.5mm amplitude at frequency of 10 ~ 55Hz in each of X, Y, Z directions for 10 minutes			
Shock	Mechanical		300m/s <sup>2</sup> (Approx. 30G) in X, Y, Z directions for 3 times			
	Malfunction		100m/s <sup>2</sup> (Approx. 10G) in X, Y, Z directions for 3 times			
Relay life cycle	Mechanical		Min. 10,000,000 times			
	Electrical		Min. 100,000 times (250VAC 3A at resistive load)			
Ambient temperature			-10 ~ +55°C (at non-freezing status)			
Storage temperature			-25 ~ +65°C (at non-freezing status)			
Ambient humidity			35 ~ 85%RH			
Unit weight			AC type : Approx. 147g, DC type : Approx. 153g		AC type : Approx. 137g, DC type : Approx. 143g	
Approval						

(A) Counter

(B) Timer

(C) Temp. controller

(D) Power controller

(E) Panel meter

(F) Tacho/Speed/Pulse meter

(G) Display unit

(H) Sensor controller

(I) Switching power supply

(J) Proximity sensor

(K) Photo electric sensor

(L) Pressure sensor

(M) Rotary encoder

(N) Stepping motor & Driver & Controller

(O) Graphic panel

(P) Production stoppage models & replacement

# FXS Series

## Connections

### FX4S

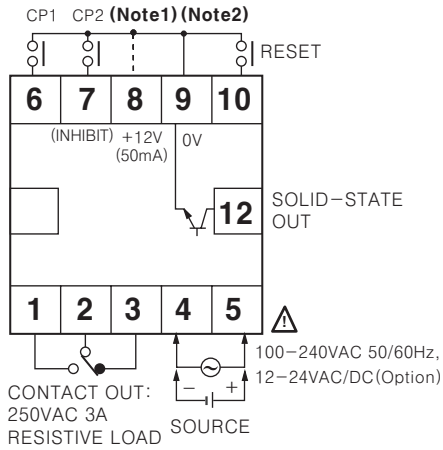

### FX5S-I

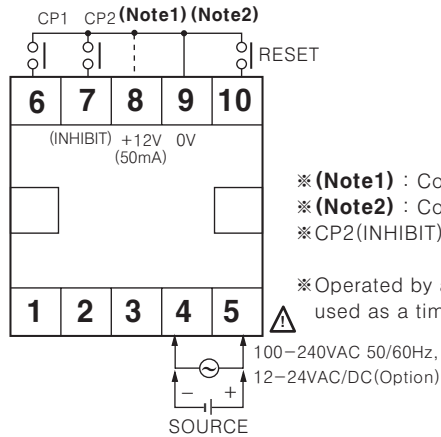

- ※ (Note1) : Connection of PNP input
- ※ (Note2) : Connection of NPN input
- ※ CP2(INHIBIT): Time Hold terminal when using for timer.
- ※ Operated by a power ON start when it is used as a timer.

## Dimensions

### Bracket

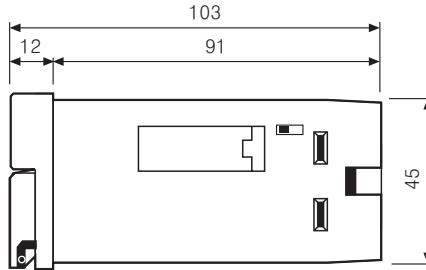
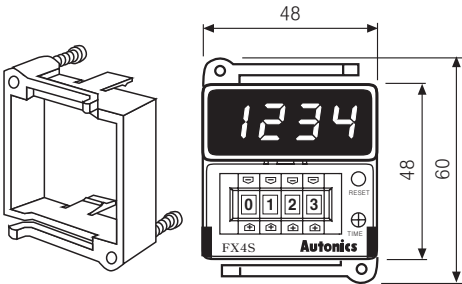

### Panel cut-out

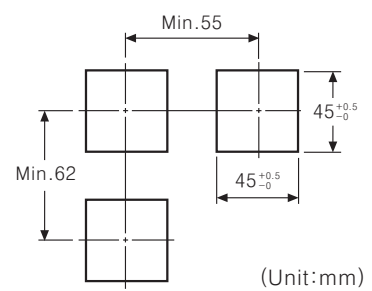

## Input connections

### Input logic : No-voltage(NPN) input

#### Solid-state input(Standard sensor : NPN output type sensor)

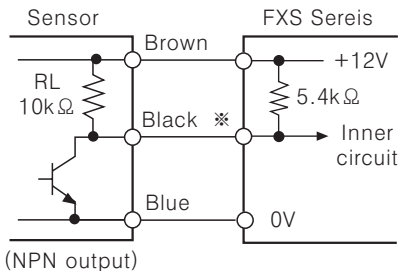

※ CP1, CP2(INHIBIT), RESET input

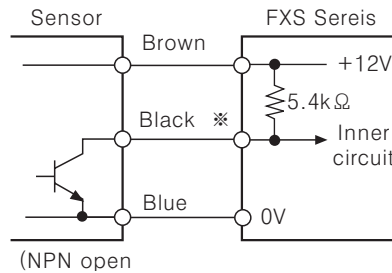

#### Contact input

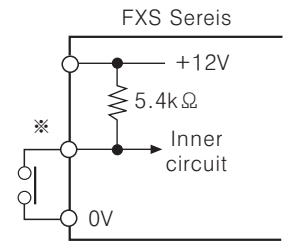

※ Please select the counting speed as 30cps when it is used for counter.

### Input logic : Voltage(PNP) input

#### Solid-state input(Standard sensor : PNP output type sensor)

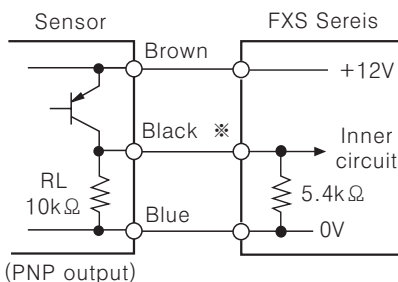

※ CP1, CP2(INHIBIT), RESET input

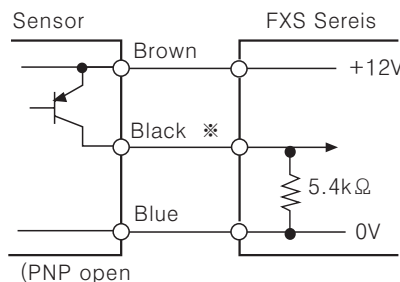

#### Contact input

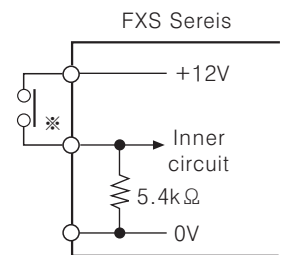

※ Please select the counting speed as 30cps when it is used for counter.

# Up/Down Counter/Timer

## Input logic selection

● Select NPN (No-voltage input)

● Select PNP (Voltage input)

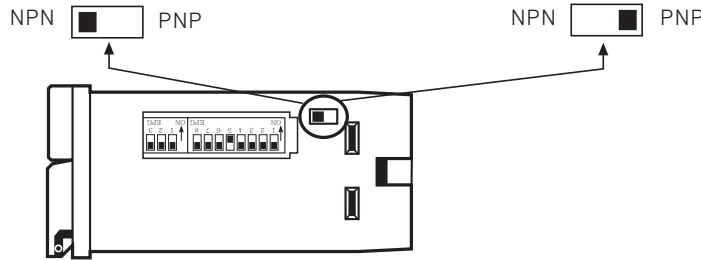

※ Please be sure to turn OFF the power before changing input logic.

## Input & Output connections

◎ In case of operating the load by power supply of the sensor

◎ In case of operating the load by external power supply

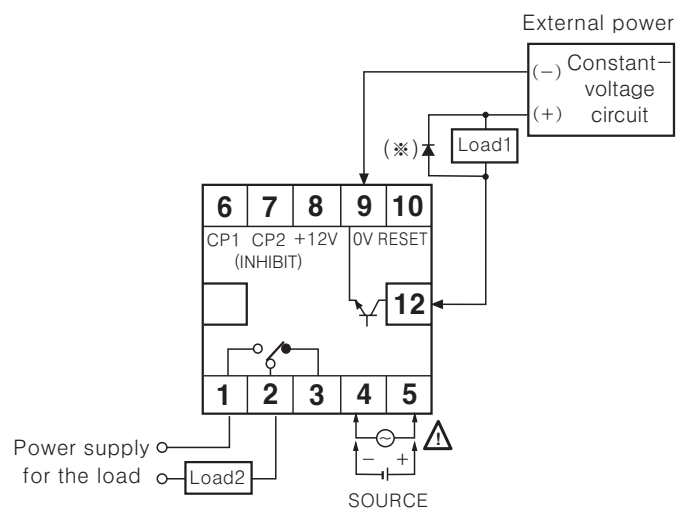
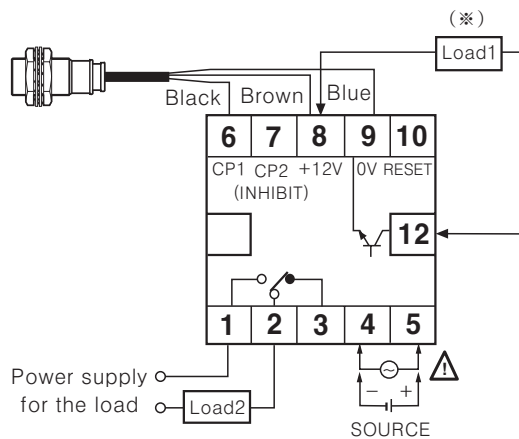

● (※) Please select proper capacity of load, because total current consumption should not exceed current capacity. (Max. 50mA)

● Contact capacity : Max. 250VAC 3A

● The capacity of Load1 must not exceed Max. 30VDC, Max. 100mA of the switching capacity of the transistor.

● Please do not supply the reverse polarity voltage.

● (※) Please connect the surge absorber (Diode) at both terminals of Load1, in case of using the inductive load. (Relay, etc.)

◎ Using 2 counters with one sensor

● It is available to use 2 counters with one sensor.

Please connect as the power of sensor is supplied from only one of counters and design input logic with same way.

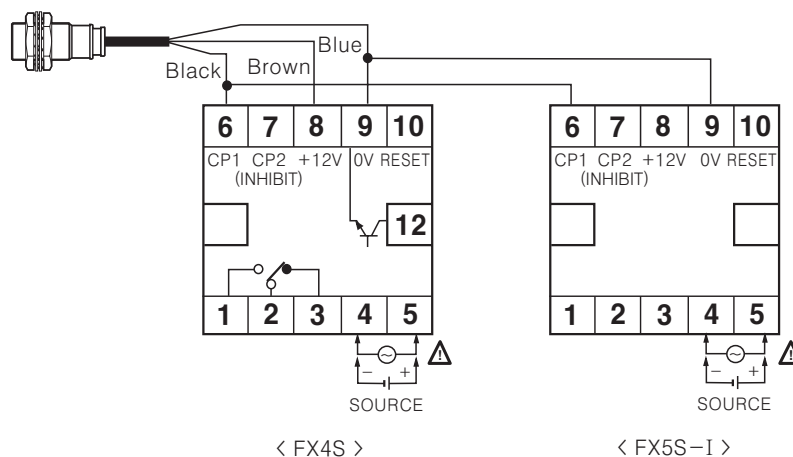

(A) Counter

(B) Timer

(C) Temp. controller

(D) Power controller

(E) Panel meter

(F) Tacho/Speed/Pulse meter

(G) Display unit

(H) Sensor controller

(I) Switching power supply

(J) Proximity sensor

(K) Photo electric sensor

(L) Pressure sensor

(M) Rotary encoder

(N) Stepping motor & Driver & Controller

(O) Graphic panel

(P) Production stoppage models & replacement

# FXS Series

## ■ Description of inner DIP switches

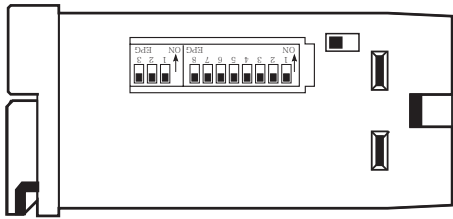

- ※ Inner selection switch is changed from 10pin to 11pin with upgrade of counting speed.
- ※ There is no output operation mode in indication type (FX5S-I) and SW2 selection switch.

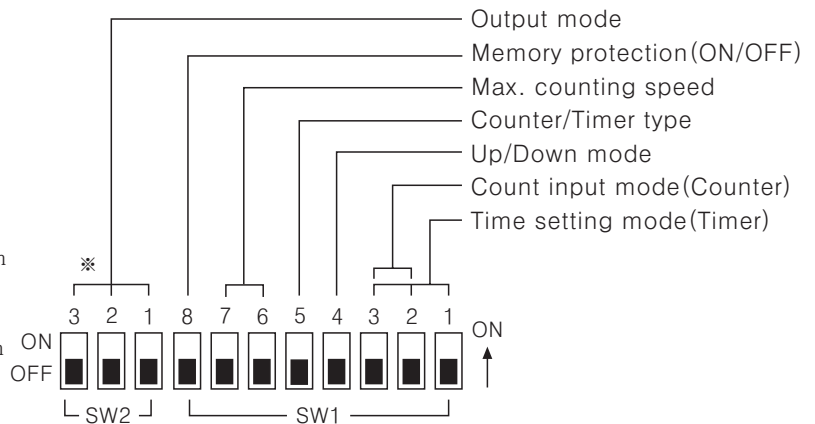

### ● Up/Down mode

SW1	Function
ON <input type="checkbox"/> OFF <input type="checkbox"/>	Down mode
ON <input type="checkbox"/> OFF <input type="checkbox"/>	Up mode

### ● Counter/Timer

SW1	Function
ON <input type="checkbox"/> OFF <input type="checkbox"/>	Counter
ON <input type="checkbox"/> OFF <input type="checkbox"/>	Timer

### ● Memory protection

SW1	Function
ON <input type="checkbox"/> OFF <input type="checkbox"/>	Disable the memory protection
ON <input type="checkbox"/> OFF <input type="checkbox"/>	Enable the memory protection

### ● Max. counting speed

SW1	CP1, CP2
ON <input type="checkbox"/> OFF <input type="checkbox"/>	1cps
ON <input type="checkbox"/> OFF <input type="checkbox"/>	30cps
ON <input type="checkbox"/> OFF <input type="checkbox"/>	2kcps
ON <input type="checkbox"/> OFF <input type="checkbox"/>	5kcps

## ■ Setting function of Decimal point

Display the decimal point.

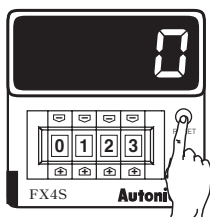

RUN mode

- ※ If press RESET button for over 3sec. it advanced to decimal point setting mode.

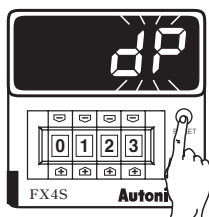

- ※ When "dP" flashes, touch RESET button once.

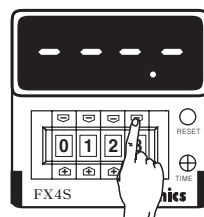

- ※ Set the position of decimal point using  $\uparrow$ ,  $\downarrow$  buttons of digital switch.

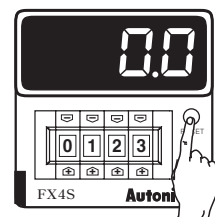

Return to RUN mode

- ※ It returns to RUN mode by press RESET button over 3sec.



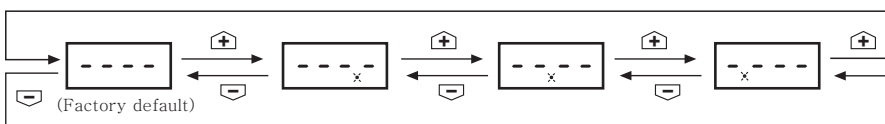











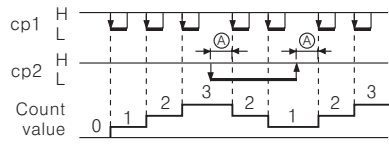
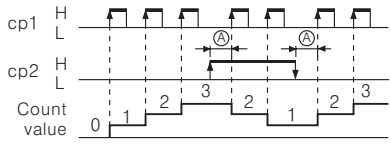

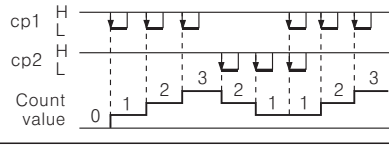
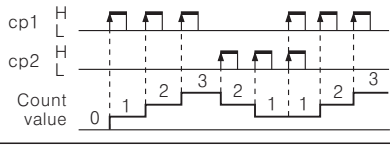

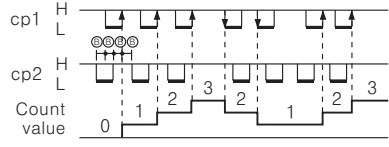
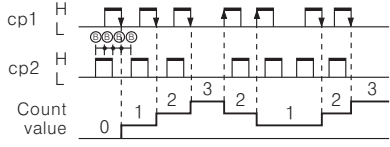

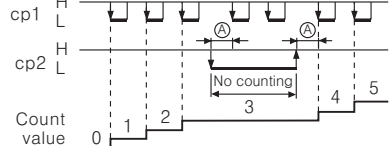
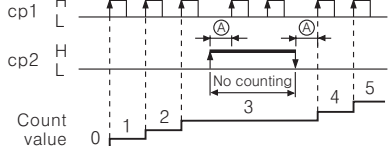
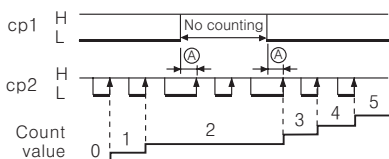
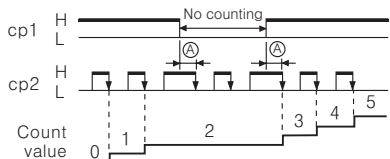
### ● Changing the decimal point

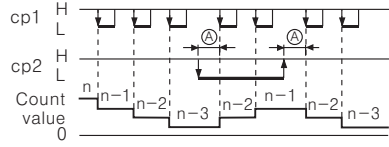
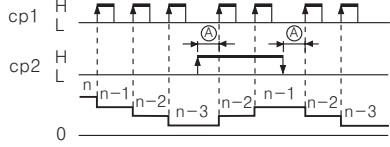

- ※ It returns to RUN mode if no RESET button or digital switch is applied for 60sec. in decimal point setting status.
- ※ The decimal point setting is not existed in indication type.

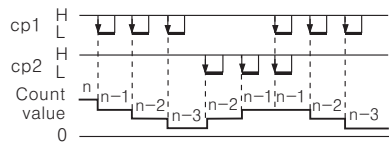
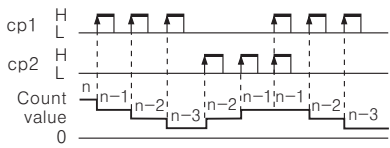
# Up/Down Counter/Timer

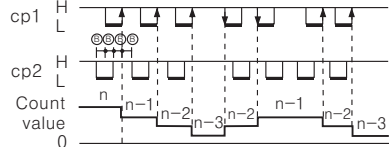
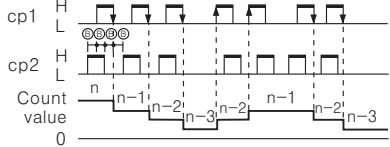
## Input operation mode(Counter)

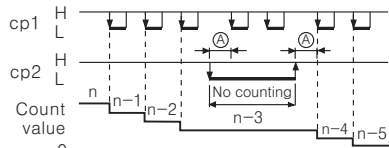
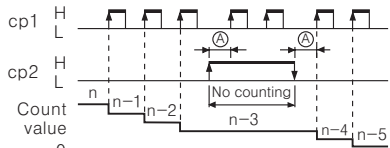
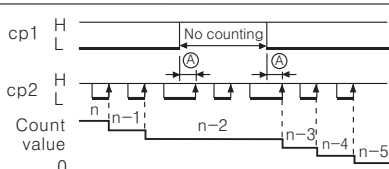
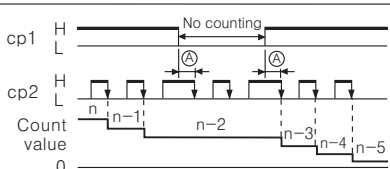
Input mode			No-voltage input(NPN)	Voltage input(PNP)	(A) Counter	
ON  OFF   Count up mode	Up/Down-A (Command input)	ON  OFF 			(B) Timer	
	Up/Down-B (Individual input)	ON  OFF 			(C) Temp. controller	
	Up/Down-C (Phase difference input)	ON  OFF 			(D) Power controller	
	Up (Count up input)	ON  OFF 			(E) Panel meter	
					(F) Tacho/Speed/Pulse meter	
	ON  OFF   Count down mode	Up/Down-D (Command input)	ON  OFF 			(I) Switching power supply
		Up/Down-E (Individual input)	ON  OFF 			(J) Proximity sensor
		Up/Down-F (Phase difference input)	ON  OFF 			(K) Photo electric sensor
Down (Count down input)		ON  OFF 			(L) Pressure sensor	
				(M) Rotary encoder		

\*Ⓐ : Over Min. signal width, Ⓑ : Over 1/2 of Min. signal width.

If the signal width of Ⓐ or Ⓑ is less than Min. signal width, ±1 of count error is occurred.

- (A) Counter
- (B) Timer
- (C) Temp. controller
- (D) Power controller
- (E) Panel meter
- (F) Tacho/Speed/Pulse meter
- (G) Display unit
- (H) Sensor controller
- (I) Switching power supply
- (J) Proximity sensor
- (K) Photo electric sensor
- (L) Pressure sensor
- (M) Rotary encoder
- (N) Stepping motor & Driver & Controller
- (O) Graphic panel
- (P) Production stoppage models & replacement

# FXS Series

## Counting operation of indication type(Counter)

### Up input mode

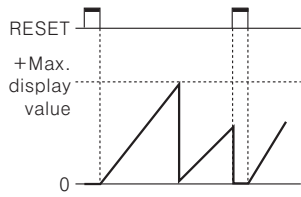

### Down input mode

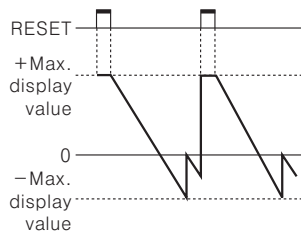

### Up/Down-A, B, C input mode

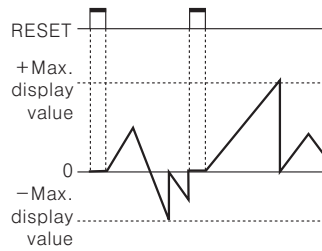

### Up/Down-D, E, F input mode

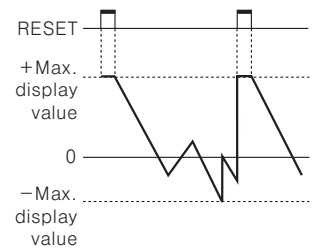

## Time operation of indication type(Timer)

### Up input mode

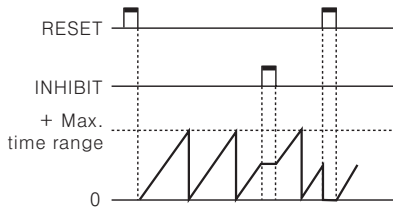

### Down input mode

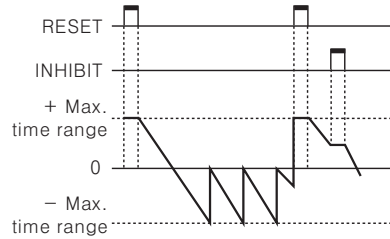

## Time setting mode(Timer)

SW1	4Digit	5Digit
1 2 3 ON [ ] [ ] [ ] OFF [ ] [ ] [ ]	99.99sec	9999.9sec
1 2 3 ON [ ] [ ] [ ] OFF [ ] [ ] [ ]	999.9sec	99999sec
1 2 3 ON [ ] [ ] [ ] OFF [ ] [ ] [ ]	9999sec	9min 59.99sec
1 2 3 ON [ ] [ ] [ ] OFF [ ] [ ] [ ]	99min 59sec	99min 59.9sec
1 2 3 ON [ ] [ ] [ ] OFF [ ] [ ] [ ]	999.9min	9999.9min
1 2 3 ON [ ] [ ] [ ] OFF [ ] [ ] [ ]	99hour 59min	9hour 59min 59sec
1 2 3 ON [ ] [ ] [ ] OFF [ ] [ ] [ ]	999.9hour	999hour 59min
1 2 3 ON [ ] [ ] [ ] OFF [ ] [ ] [ ]	9999hour	9999.9hour

# Up/Down Counter/Timer

## Output operation mode (by internal DIP switch)

■ ← One-shot output (0.05~5sec)

□ ← Retained output

Output mode (SW1)	ON 4 OFF 1		Operation after count up
	Up mode Up / Down-A, B, C	Down mode Up / Down-D, E, F	
<b>F</b> 8 9 10 ON [ ] [ ] [ ] OFF [ ] [ ] [ ]			The display value continues until reset signal is applied then output is held. • Retained output will be maintained until Reset signal is applied.
<b>N</b> 8 9 10 ON [ ] [ ] [ ] OFF [ ] [ ] [ ]			Display value and retained output are maintained until Reset signal is applied.
<b>C</b> 8 9 10 ON [ ] [ ] [ ] OFF [ ] [ ] [ ]			The display value returns to reset start status as soon as display value is reached to preset value.
<b>R</b> 8 9 10 ON [ ] [ ] [ ] OFF [ ] [ ] [ ]			The display value is held until output is OFF then returns to reset start status.
<b>K</b> 8 9 10 ON [ ] [ ] [ ] OFF [ ] [ ] [ ]			The display value continues until reset signal is applied.
<b>P</b> 8 9 10 ON [ ] [ ] [ ] OFF [ ] [ ] [ ]			The display value is held during one-shot output time, counting process is returned to reset start status as soon as output is ON.
<b>Q</b> 8 9 10 ON [ ] [ ] [ ] OFF [ ] [ ] [ ]			The display value continues during one-shot output time.
<b>S</b>	<b>Up input</b>	<b>Down input</b>	<ul style="list-style-type: none"> <li>• Up, UP/Down-A, B, C input mode - Output is ON when (Display value) ≥ (Preset value)</li> <li>• Down, UP/Down-D, E, F input mode - Output is ON when (Display value) ≤ (Zero)</li> </ul>
Counter 8 9 10 ON [ ] [ ] [ ] OFF [ ] [ ] [ ]	<b>Up / Down-A, B, C</b>	<b>Up / Down-D, E, F</b>	
<b>S</b> Timer 8 9 10 ON [ ] [ ] [ ] OFF [ ] [ ] [ ]			The output turns ON after the setting time and then turns OFF after the setting time. This operation is repeated sequentially. (Flashing)

\*One-shot output time is set by front TIME adjuster.

(A) Counter

(B) Timer

(C) Temp. controller

(D) Power controller

(E) Panel meter

(F) Tacho/Speed/Pulse meter

(G) Display unit

(H) Sensor controller

(I) Switching power supply

(J) Proximity sensor

(K) Photo electric sensor

(L) Pressure sensor

(M) Rotary encoder

(N) Stepping motor & Driver & Controller

(O) Graphic panel

(P) Production stoppage models & replacement

# FXS Series

## ■ Proper usage

### ◎ Reset function

#### ● Reset

In case of changing the input mode after supplying the power, please take external reset or manual reset. **If reset is not executed, the counter will be working as previous mode.**

#### ● Reset signal width

It is reset perfectly when the reset signal is applied during **max. 20ms** regardless of the contact input & solid-state input.

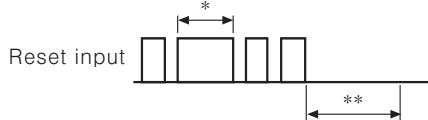

\*In case of a contact reset, it is reset perfectly if the ON time of reset signal is applied during max. 20ms even though a chattering is occurred.

\*\*It can be input the signal of CP1, CP2 after max. 50ms from closing time of reset signal.

### ◎ Sensor power

The power 12VDC which is provided to sensor is built in it. Please use it under Max. 50mADC.

### ◎ Min. signal width of CP1, CP2 input

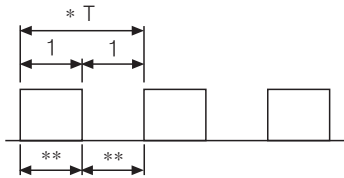

\*Please make duty ratio(ON/OFF) 1:1

\*\* Min. signal width

- 1cps : Min. 500ms
- 30cps : Min. 16.7ms
- 2kcps : Min. 0.25ms
- 5kcps : Min. 0.1ms

### ◎ Max. counting speed

This is a response speed per 1 sec. when the duty ratio(ON:OFF) of input signal is 1:1.

If the duty ratio is not 1:1, the width between ON and OFF should be over min. signal width and the response speed will getting slower against input signal. And one of ON width and OFF width is under min. signal width, this product may not respond.

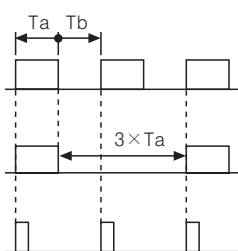

Width of  $T_a$ (ON) and  $T_b$ (OFF) must be larger than Min. signal width.

Max. counting speed is 1/2 value of catalog spec. when duty ratio is 1:3.

It can not respond because Max. signal width ( $1a$ ) is small.

### ◎ INHIBIT(When using as Timer)

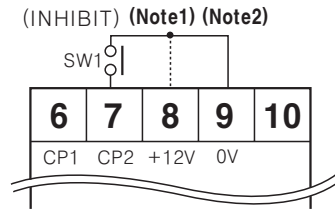

※ (Note1):PNP input  
 (Note2):NPN input

- If SW1 is ON, it becomes INHIBIT. (Time Hold)
- When power is applied, it starts to progress and INHIBIT mode is used to stop the time is under the progress at the moment.
- When SW1 is OFF, timer starts to progress again.

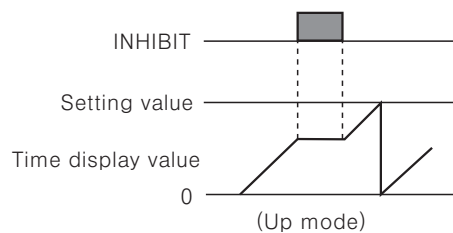

### ◎ Error display

Error signal	Error description	Returning method
Err0	Zero setting status	Change the setting value to non zero status

※ When Error is displayed, the output continues OFF state.  
 ※ There is no Error function in indicator.

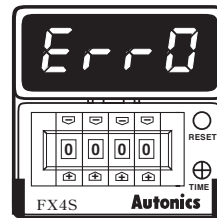

### ◎ Power

The inner circuit voltage starts to rise up for the first 100ms after power on, the input may not work at this time. And also the inner circuit voltage drops down for the last 500ms after power off, the input may not work at this time.

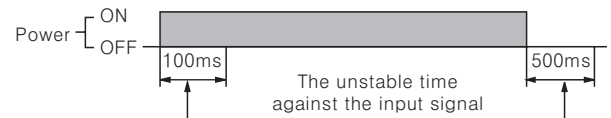

### ◎ Case & DIP switch detachment

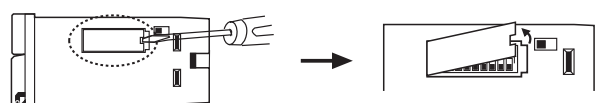

Push a lock part to front direction and widen it simultaneously.

※ Please be careful of the injury caused by tools.

# Up/Down Counter/Timer

## DIN W72 × H72, W48 × H96, W144 × H72mm Counter/Timer

### Features

- 36 input modes and 20 output modes
- Counting speed : 1cps/30cps/2kcps/5kcps
- Selectable voltage input (PNP) or No voltage input (NPN)
- Addition of Up/Down input mode
- Wide range of power supply : 100–240VAC 50/60Hz  
12–24VAC/DC (Option)
- Selectable Counter/Timer by internal DIP switch
- Various time range
- Built-in Microprocessor



**⚠ Please read "Caution for your safety" in operation manual before using.**



### Specifications

Model	Single preset	FX4	FX6	FX4H	—	—
	Dual preset	FX4-2P	FX6-2P	FX4H-2P	FX4L-2P	FX6L-2P
	Totalizer(Indicator)	FX4-I	FX6-I	FX4H-I	FX4L-I	FX6L-I
Digit		4	6	4	4	6
Digit size		W8×H14mm	W4×H8mm	W6×H10mm	W8×H14mm	
Power supply	100–240VAC 50/60Hz, 12–24VAC/DC (Option)					
Allowable voltage range	90 ~ 110% of rated voltage					
Power consumption	<ul style="list-style-type: none"> <li>• Indicator : Approx. 6VA(240VAC 60Hz), Approx. 2.7W(24VDC), Approx. 5.8VA(24VAC 60Hz)</li> <li>• Single preset : Approx. 7VA(240VAC 60Hz), Approx. 3.3W(24VDC), Approx. 6.8VA(24VAC 60Hz)</li> <li>• Dual preset: Approx. 8VA(240VAC 60Hz), Approx. 3.8W(24VDC), Approx. 7.6VA(24VAC 60Hz)</li> </ul>					
Max. counting speed for CP1, CP2	Selectable 1cps/30cps/2kcps/5kcps by internal DIP switch					
Min. input signal width	RESET input	Approx. 20ms				
	INHIBIT input					
Input	CP1, CP2 input (INHIBIT)	Input logic is selectable [Voltage input] Input impedance : 5.4kΩ, "H" level : 5–30VDC, "L" level : 0–2VDC [No-voltage input] Impedance at short-circuit : Max. 1kΩ, Residual voltage at short-circuit : Max. 2VDC, Impedance at open-circuit : Min. 100kΩ				
	RESET input					
One-shot output time	<ul style="list-style-type: none"> <li>• Single preset type ⚡ 0.05~5sec</li> <li>• Dual preset type ⚡ 1st. output 0.5sec fixed, 2st. output : 0.05~5sec</li> </ul>					
Control output	Contact	Type	Single preset type : SPDT(1c), Dual preset type : 1st output SPDT(1c), 2nd output SPDT(1c)			
		Capacity	250VAC 3A at resistive load			
	Solid-state	Type	Single preset type : 1 NPN open collector Dual preset type : 1st output 1 NPN open collector, 2nd output 1 NPN open collector			
Capacity		30VDC Max. 100mA Max.				
Memory protection	10 years(When using non-volatile semiconductor memory)					
External sensor power	12VDC ±10% 50mA Max.					
Ambient temperature	-10 ~ +55°C (at non-freezing status)					
Storage temperature	-25 ~ +65°C (at non-freezing status)					
Ambient humidity	35 ~ 85%RH					
Insulation resistance	Min. 100MΩ (at 500VDC mega)					
Dielectric strength	2000VAC 50/60Hz for 1 minute					
Noise strength	AC power	±2kV the square wave noise(pulse width:1μs) by the noise simulator				
	DC power	±500V the square wave noise(pulse width:1μs) by the noise simulator				

(A) Counter

(B) Timer

(C) Temp. controller

(D) Power controller

(E) Panel meter

(F) Tacho/Speed/Pulse meter

(G) Display unit

(H) Sensor controller

(I) Switching power supply

(J) Proximity sensor

(K) Photo electric sensor

(L) Pressure sensor

(M) Rotary encoder

(N) Stepping motor & Driver & Controller

(O) Graphic panel

(P) Production stoppage models & replacement

# FX/FXH/FXL Series

## Specifications

Vibration	Mechanical	0.75mm amplitude at frequency of 10 ~ 55Hz in each of X, Y, Z directions for 1 hour			
	Malfunction	0.5mm amplitude at frequency of 10 ~ 55Hz in each of X, Y, Z directions for 10 minutes			
Shock	Mechanical	300m/s <sup>2</sup> (Approx. 30G) in X, Y, Z directions for 3 times			
	Malfunction	100m/s <sup>2</sup> (Approx. 10G) in X, Y, Z directions for 3 times			
Relay life cycle	Mechanical	Min. 10,000,000 operations			
	Electrical	Min. 100,000 operations at 250VAC 2A (resistive load)			
Approval					
Unit weight	FX4 : Approx. 295g FX4-2P : Approx. 305g FX4-I : Approx. 260g	FX6 : Approx. 305g FX6-2P : Approx. 315g FX6-I : Approx. 265g	FX4H : Approx. 325g FX4H-2P : Approx. 353g FX4H-I : Approx. 297g	FX4L-2P : Approx. 544g FX4L-I : Approx. 455g	FX6L-2P : Approx. 550g FX6L-I : Approx. 461g

## Connections

### FX□-2P

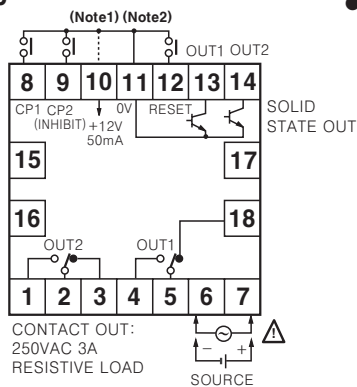

### FX□

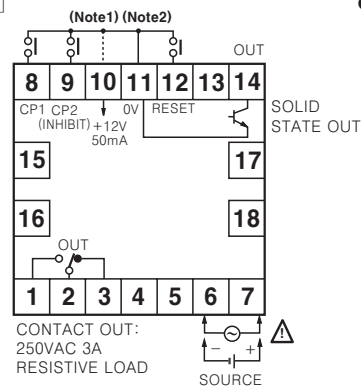

### FX□-I

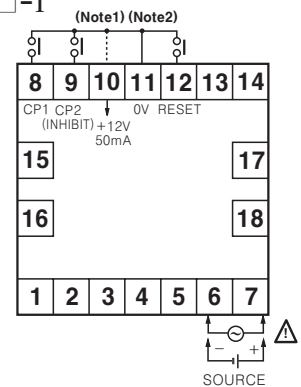

### FX4H-2P

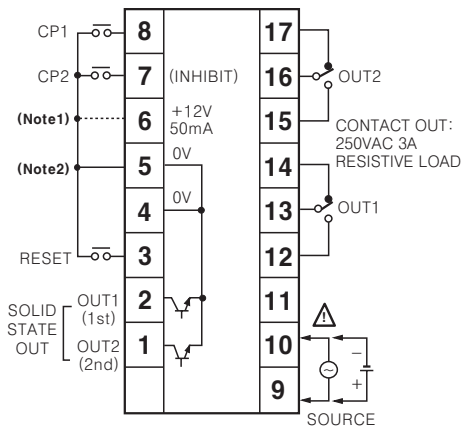

### FX4H

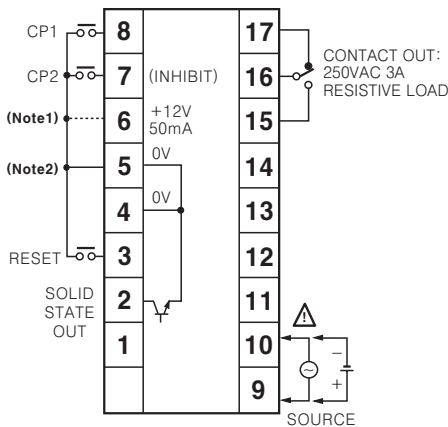

### FX4H-I

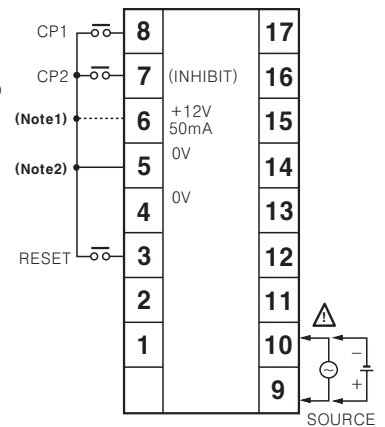

### FX□L-2P

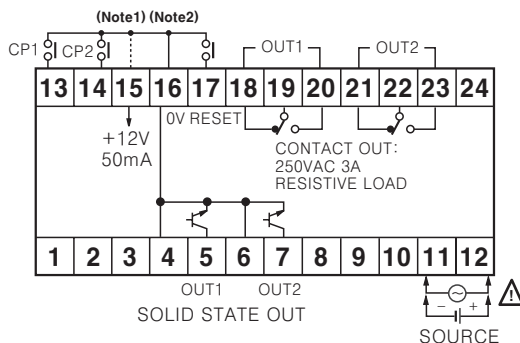

### FX□L-I

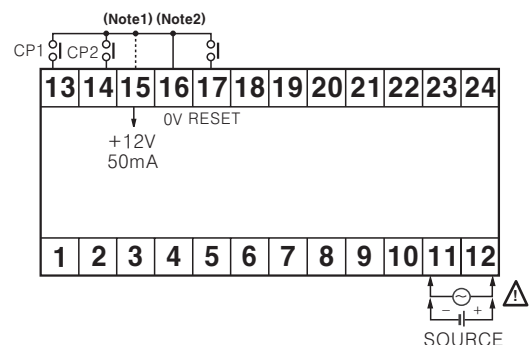

※ CP2(INHIBIT) : Time hold terminal when using for timer.  
 ※ It is operated by power ON start type when using for timer.

※ (Note1) : Connection for PNP input  
 (Note2) : Connection for NPN input

# Up/Down Counter/Timer

## Dimensions

### ●FX Series

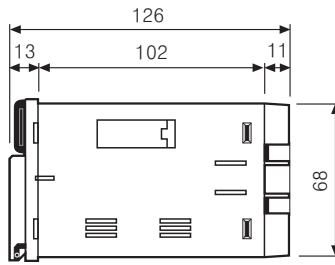
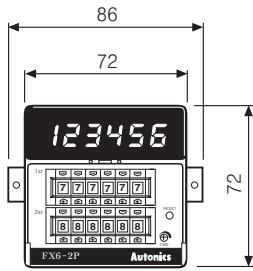

### ●Panel cut-out

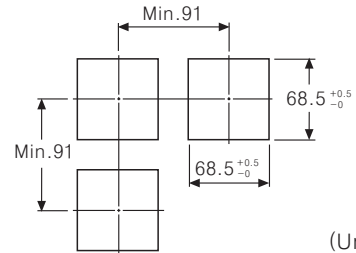

(Unit:mm)

### ●FXH Series

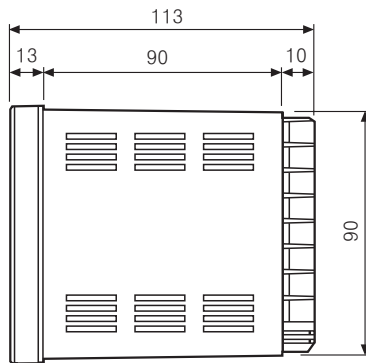
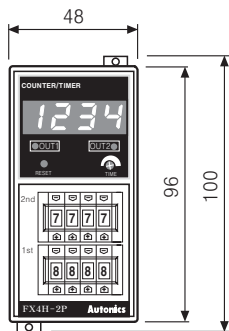

### ●Panel cut-out

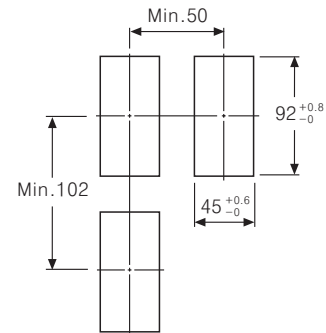

(Unit:mm)

### ●FXL Series

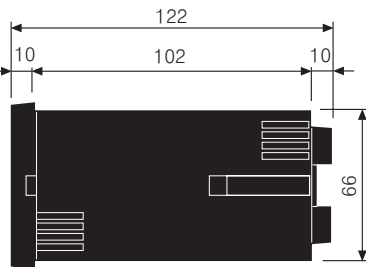
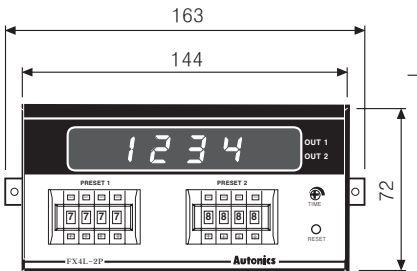

### ●Panel cut-out

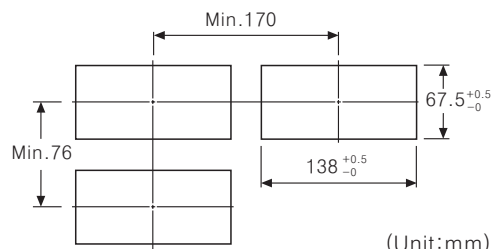

(Unit:mm)

## Input connections

### ○No-voltage input (NPN)

#### ●Solid-state input (Standard input sensor : NPN output type sensor)

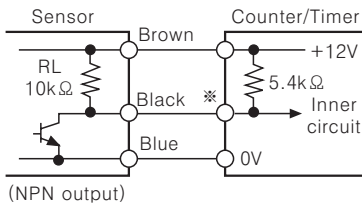

※CP1, CP2(INHIBIT), RESET input

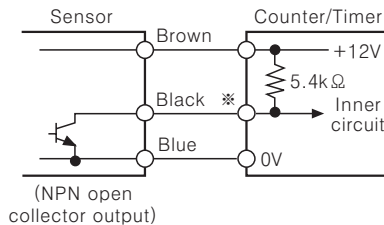

#### ●Contact input

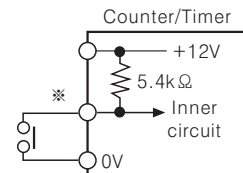

Counting speed :  
1 or 30cps setting(Counter)

### ○Voltage input (PNP)

#### ●Solid-state input (Standard input sensor : PNP output type sensor)

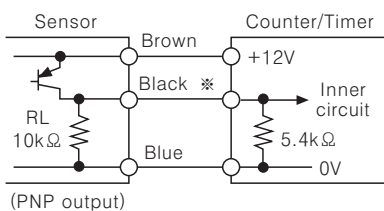

※CP1, CP2(INHIBIT), RESET Input

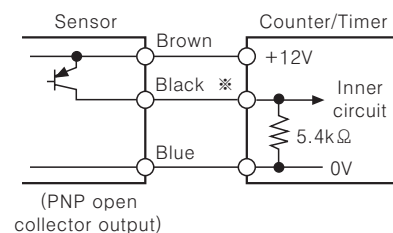

#### ●Contact input

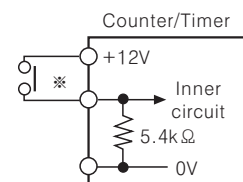

Counting speed :  
1 or 30cps setting(Counter)

(A)  
Counter

(B)  
Timer

(C)  
Temp.  
controller

(D)  
Power  
controller

(E)  
Panel  
meter

(F)  
Tacho/  
Speed/  
Pulse  
meter

(G)  
Display  
unit

(H)  
Sensor  
controller

(I)  
Switching  
power  
supply

(J)  
Proximity  
sensor

(K)  
Photo  
electric  
sensor

(L)  
Pressure  
sensor

(M)  
Rotary  
encoder

(N)  
Stepping  
motor &  
Driver &  
Controller

(O)  
Graphic  
panel

(P)  
Production  
stoppage  
models &  
replacement

# FX/FXH/FXL Series

## Input logic selection

### FX series

Input logic is changeable by input logic selection switch located at the one-side of case.

- No-voltage input (NPN)
- Voltage input (PNP)

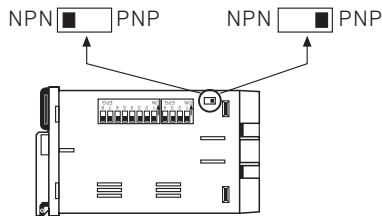

### FXL series

Input logic is changeable by input logic selection switch located at the terminal block.

- No-voltage input (NPN)



- Voltage input (PNP)



### FXH series

Input logic is changeable by input logic selection switch (SW3) located at inside of the case.

- No-voltage input (NPN)

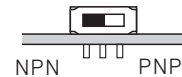

← Direction of front display

- Voltage input (PNP)

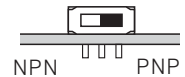

← Direction of front display

※Please be sure to turn power OFF before changing input logic.

## Input & output connections

◎In case of operating the load by power supply of the sensor

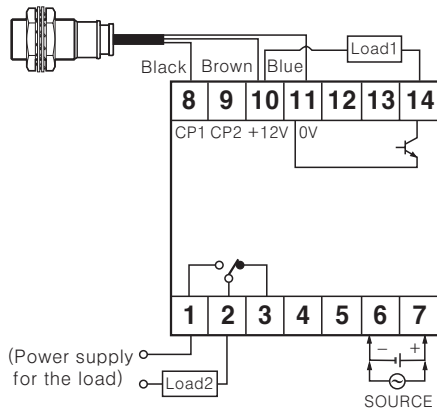

- Please select proper capacity of load, because total value of load capacity and current consumption should not be exceed current capacity. (Max. 50mA)

◎In case of operating the load by external power supply

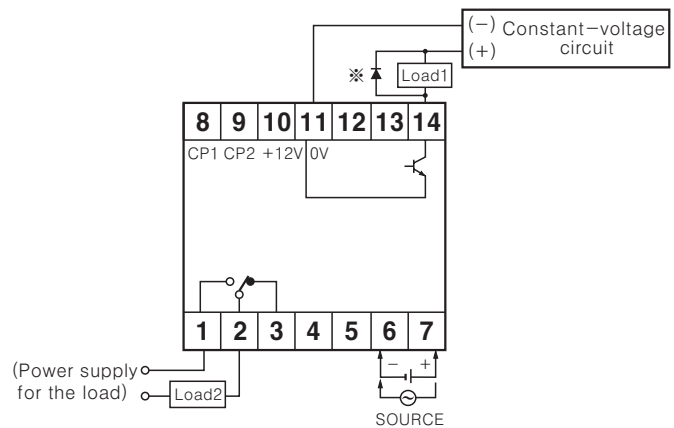

- The capacity of the load must not be exceed max. 30VDC, max. 100mA of the switching capacity of the transistor.
- Please do not supply the reverse polarity voltage.
- ※Please connector the surge absorber (Diode) at both terminals of the load, in case of using the inductive load. (Relay, etc.)

◎How to count by external power supply

This unit starts to count when "High" level (5-30VDC) is applied at CP1 or CP2 after selecting PNP.

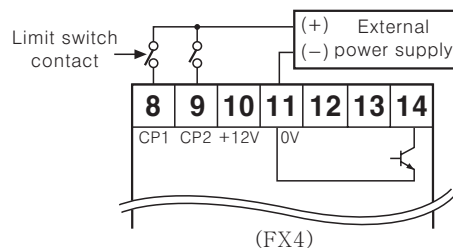

◎Using 2 counters with one sensor

- Please connect as the power of sensor is supplied from only one of counters and design input logic with same way.

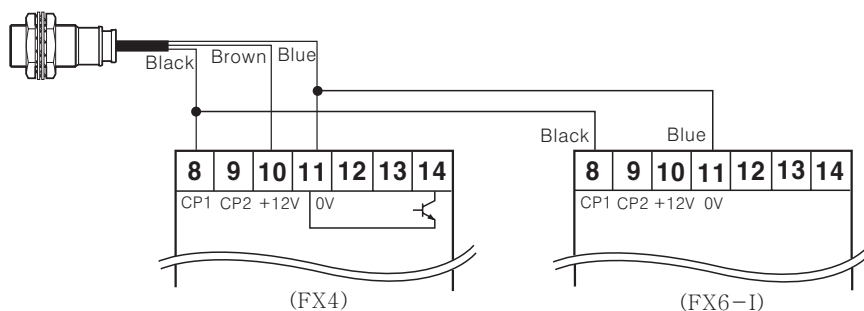

# Up/Down Counter/Timer

## ■ Selection by DIP switches

● 72×72 DIP switch position

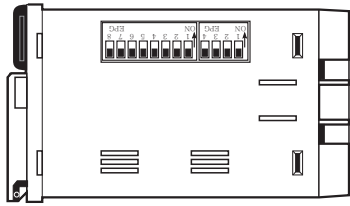

● 48×96 DIP switch position

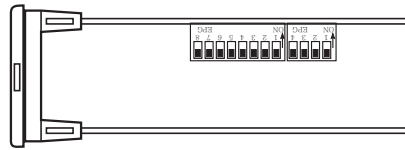

● 144×72 DIP switch position

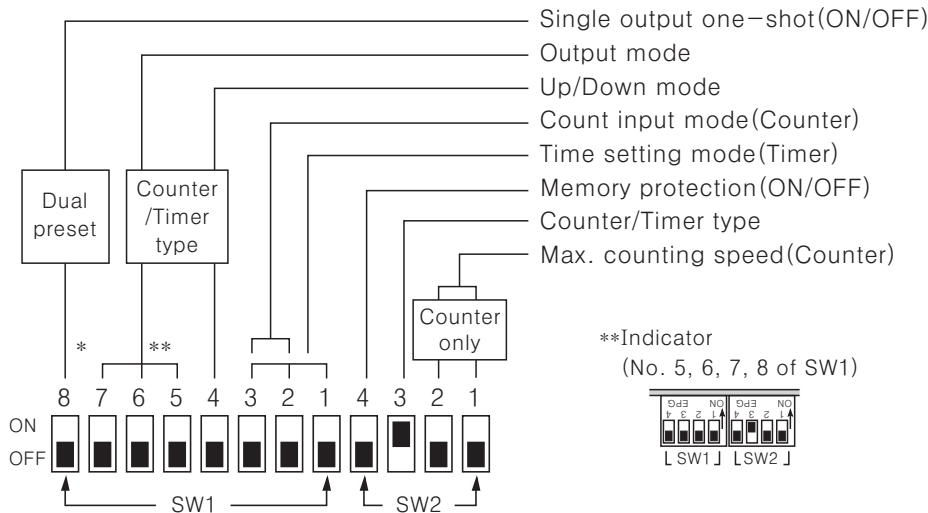
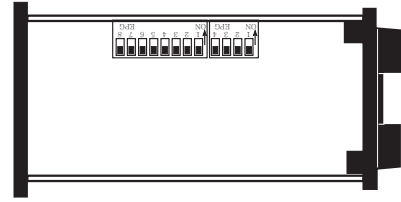

● Max. counting speed

SW2	Functions
ON 1 2 OFF 1 2	1cps
ON 1 2 OFF 1 2	30cps
ON 1 2 OFF 1 2	2kcps
ON 1 2 OFF 1 2	5kcps

● Conter/Timer

SW2	Functions
ON 3 OFF 3	Conter
ON 3 OFF 3	Timer

● Up/Down mode

SW1	Functions
ON 4 OFF 4	Down mode
ON 4 OFF 4	Up mode

● Memory protection

SW2	Functions
ON 4 OFF 4	Disable the memory protection
ON 4 OFF 4	Enable the memory protection

● Selection of one-shot output or Retained output for 1st output.

SW1	Function
ON 8 OFF 8	1st output : One-shot output
ON 8 OFF 8	1st output : Retained output

※ This mode selects a one-shot output (0.5sec fixed) or retained output (Until 2nd output turns off) for 1st output in the dual preset counter.

※ Example of F output operation mode

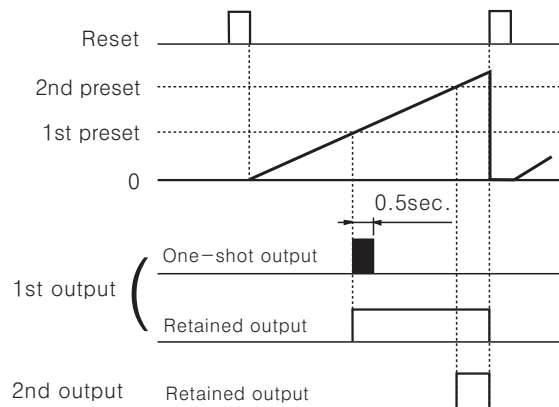

(A) Counter

(B) Timer

(C) Temp. controller

(D) Power controller

(E) Panel meter

(F) Tacho/Speed/Pulse meter

(G) Display unit

(H) Sensor controller

(I) Switching power supply

(J) Proximity sensor

(K) Photo electric sensor

(L) Pressure sensor

(M) Rotary encoder

(N) Stepping motor & Driver & Controller

(O) Graphic panel

(P) Production stoppage models & replacement

# FX/FXH/FXL Series

## Input operation(Counter)

Input mode		SW1	No-voltage input type(NPN)	Voltage input type(PNP)
Up mode	Up/Down-A (Command input)	ON  OFF 		
	Up/Down-B (Individual input)	ON  OFF 		
	Up/Down-C (Phase difference input)	ON  OFF 		
	Up (Count up input)	ON  OFF 		
Down mode	Up/Down-D (Command input)	ON  OFF 		
	Up/Down-E (Individual input)	ON  OFF 		
	Up/Down-F (Phase difference input)	ON  OFF 		
	Down (Count down input)	ON  OFF 		

※ (A) : Over Min. signal width, (B) : Over 1/2 of Min. signal width.

If the signal width of (A) or (B) is less than Min. signal width, ±1 of count error is occurred.

# Up/Down Counter/Timer

## Time setting mode(timer)

	SW1	4Digit	6Digit
<b>A</b>		99.99sec	99999.9sec
<b>B</b>		999.9sec	999999sec
<b>C</b>		9999sec	99min 59.99sec
<b>D</b>		99min 59sec	999min 59.9sec
<b>E</b>		999.9min	99999.9min
<b>F</b>		99hour 59min	99hour 59min 59sec
<b>G</b>		999.9hour	9999hour 59min
<b>H</b>		9999hour	99999.9hour

## Counting operation of indication type(Counter)

### Up mode

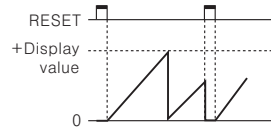

### Down mode

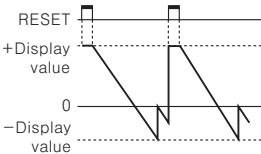

### Up / Down-A, B, C mode

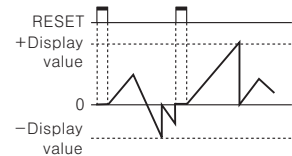

### Up / Down-D, E, F mode

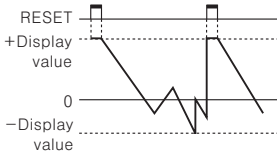

## Time operation of indication type (Timer)

### Up mode

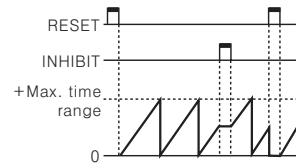

### Down mode

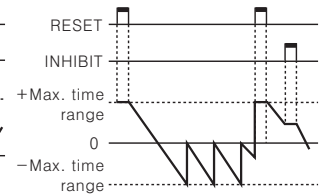

## Decimal point setting

Display the decimal point.

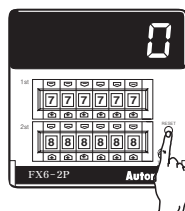

RUN mode

※ Press RESET button for over 3sec., it advances to decimal point setting mode.

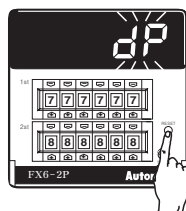

※ When "dP" is flashing, one touch the Reset button.

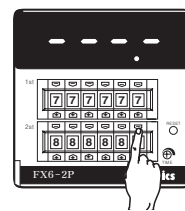

※ Set the position of decimal point using  $\uparrow$ ,  $\downarrow$  buttons of digital switch.

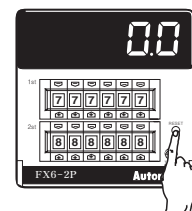

Return to RUN mode

※ Press RESET button for over 3sec., it returns to RUN mode

### Changing the decimal point

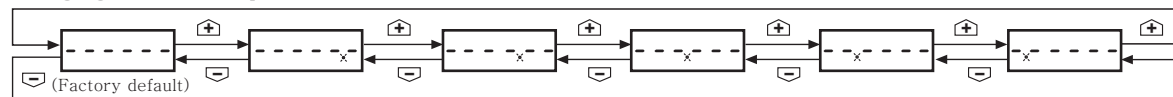

※ It returns to RUN mode if no RESET button or digital switch is applied for 60sec. in decimal point. Setting status.

※ The decimal point setting is not existed in indication type.

(A) Counter

(B) Timer

(C) Temp. controller

(D) Power controller

(E) Panel meter

(F) Tacho/Speed/Pulse meter

(G) Display unit

(H) Sensor controller

(I) Switching power supply

(J) Proximity sensor

(K) Photo electric sensor

(L) Pressure sensor

(M) Rotary encoder

(N) Stepping motor & Driver & Controller

(O) Graphic panel

(P) Production stoppage models & replacement

# FX/FXH/FXL Series

## Output operation mode

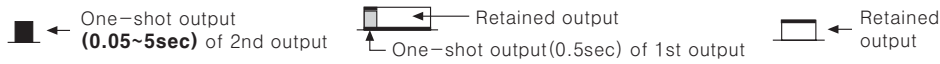

※The output of single preset type is operated at the status of the second output mode

Output mode (SW1)	ON  OFF	ON  OFF	Operation after count up
	Up mode Up, Up / Down-A, B, C	Down mode Down, Up / Down-D, E, F	
<b>F</b> ON  OFF			The display value continues until Reset signal applied and the output is held. • 1st retained output and 2nd output are maintained until Reset signal is applied. • When using 1st output as one-shot output, it will return after operating for 0.5sec.
<b>N</b> ON  OFF			The display value and output will be held until Reset input is applied.
<b>C</b> ON  OFF			The display value will be Reset Start status as soon as it reaches to 2nd setting value. • 1st retained output will be OFF after 2nd one-shot output. • 1st one-shot output will be reset after operating 0.5sec., and it is not related to 2nd output.
<b>R</b> ON  OFF			Display value will be maintained until 2nd output is Off, then it will be reset. • 1st retained output will be OFF after 2nd one-shot output. • 1st one-shot output will be reset after operating 0.5sec., and it is not related to 2nd output.
<b>K</b> ON  OFF			The display value continues until Reset signal applied. • 1st retained output will be OFF after 2nd one-shot output. • 1st one-shot output will be reset after operating 0.5sec., and it is not related to 2nd output.
<b>P</b> ON  OFF			The display value will be Reset Start status as soon as it reaches to 2nd setting value. • 1st retained output will be OFF after 2nd one-shot output. • 1st one-shot output will be reset after operating 0.5sec., and it is not related to 2nd output.
<b>Q</b> ON  OFF			The display continues until 2nd output is OFF. • 1st retained output will be OFF after 2nd one-shot output. • 1st one-shot output will be reset after operating 0.5sec. not related to 2nd output.
<b>S</b> Counter ON  OFF	<b>Up</b>	<b>Down</b>	• Up, Up/Down-A, B, C input mode -OUT1 is ON when (Display value) ≥ (1st setting value) -OUT2 is ON when (Display value) ≥ (Dual setting value)  • Down, Up/Down-D, E, F input mode -OUT1 is ON when (Display value) ≤ (1st setting value) -OUT2 is ON when (Display value) ≤ (Zero)
	<b>Up / Down-A, B, C</b>	<b>Up / Down-D, E, F</b>	
<b>S</b> Timer ON  OFF			When it is used as Timer, 1st output and 2nd output are flashing repeatedly.

※One-shot output time is set by front TIME adjuster.

# Up/Down Counter/Timer

## Proper usage

### Reset

#### Reset

In case of changing the input mode after supplying the power, please provide an external reset or manual reset. **If reset is not executed, the counter will be working in previous mode.**

#### Reset signal width

To guarantee proper reset, the signal must be supplied for a minimum of **min. 20ms** regardless the signal comes from a contact or a solid-state input.

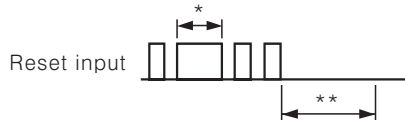

\*In case of a contact reset, contact chattering will not affect the reset as long as it is applied for a minimum of 20ms.

\*\*Input signal at CP1 & CP2 must be applied for a minimum of 50ms after the reset is removed.

### Minimum count signal width

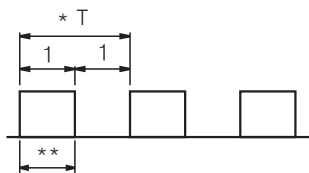

\* Please make duty ratio(ON/OFF) as 1:1.

\*\*Minimum signal width  $\left[ \begin{array}{l} 30\text{cps} : \text{Min. } 16.7\text{ms} \\ 2\text{kcps} : \text{Min. } 0.25\text{ms} \end{array} \right.$

### Maximum counting speed

This is a response speed per 1 sec. when the duty ratio (ON:OFF) of input signal is 1:1. If the duty ratio is not 1:1, the width between ON and OFF should be over min. signal width and the response speed will getting slower against input signal. If either ON or OFF signal is shorter than minimum signal width, this product may not respond.

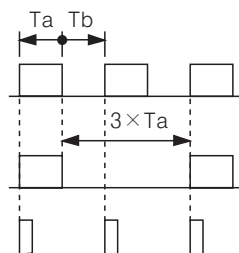

Therefore  $T_a$ (ON width) and  $T_b$ (OFF width) needed to be over min. signal width.

Max. counting speed is 1/2 value of catalog spec. when duty ratio is 1:3.

It can not respond because Max. signal width(1a) is small.

### Power

The inner circuit voltage starts to rise up for the first 100ms after power on, the input may not work at this time. And also the inner circuit voltage drops down for the last 500ms after power off, the input may not work at this time.

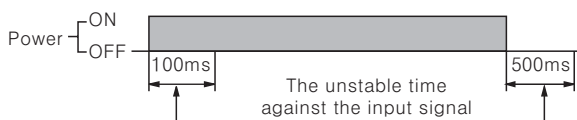

### INHIBIT(Only Timer)

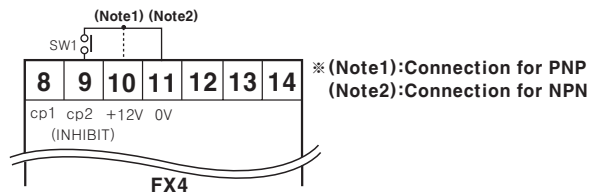

- INHIBIT mode is active when SW1 turns ON. (Time Hold)
- When power is applied, it starts to progress and INHIBIT mode is used to stop the time is under the progress at the moment.
- When SW1 is OFF, timer starts to progress again.

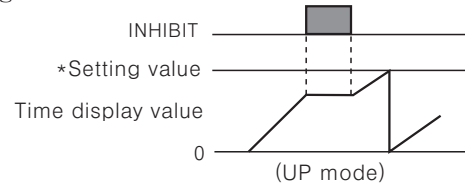

### How to use the sticker

The below sticker can be found inside the box. Use the sticker according to application as follow:  
Ex1) Measurement of length by the rotary encoder      Ex2) Timer[F mode]

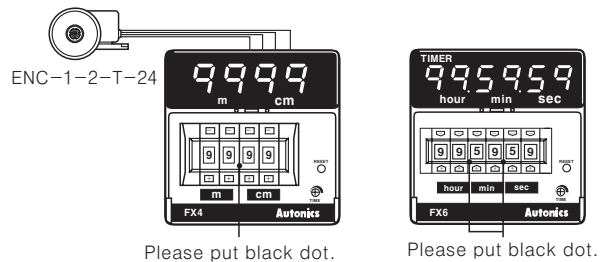

### Error display

Error signal	Error description	Returning method
Err0	Zero setting status	Change the setting value to non zero status
	When 2nd setting value is smaller than 1st setting value	Make 2nd setting value bigger than 1st setting value

- \*There is no Error display function in indication type.
- \*There is no Error function in indicator.

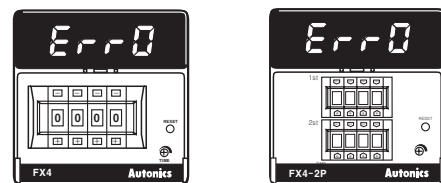

## Case & DIP switch detachment

### FXH Series

- 1 Push down the front guide.
- 2 Pull out the front guide.

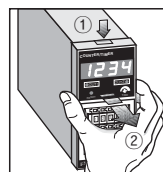

### FXL Series

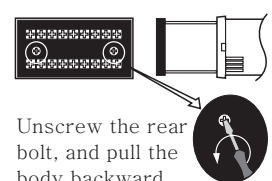

\*Please be careful of the injury caused by tools.

(A) Counter

(B) Timer

(C) Temp. controller

(D) Power controller

(E) Panel meter

(F) Tacho/Speed/Pulse meter

(G) Display unit

(H) Sensor controller

(I) Switching power supply

(J) Proximity sensor

(K) Photo electric sensor

(L) Pressure sensor

(M) Rotary encoder

(N) Stepping motor & Driver & Controller

(O) Graphic panel

(P) Production stoppage models & replacement